



C.F.R. S.r.l.
Modena - Italy

POTENZA
POWER
300 W

TENSIONE
TENSION
80 V

VELOCITA'
SPEED
2800 Rpm

COPPIA
TORQUE
1.02 Nm

PROTEZIONE
ENCLOSURE
IP 44

PESO
WEIGHT
5 Kg

CODICE
CODE
MP102.S0007
DATA
DATE
30/03/2009

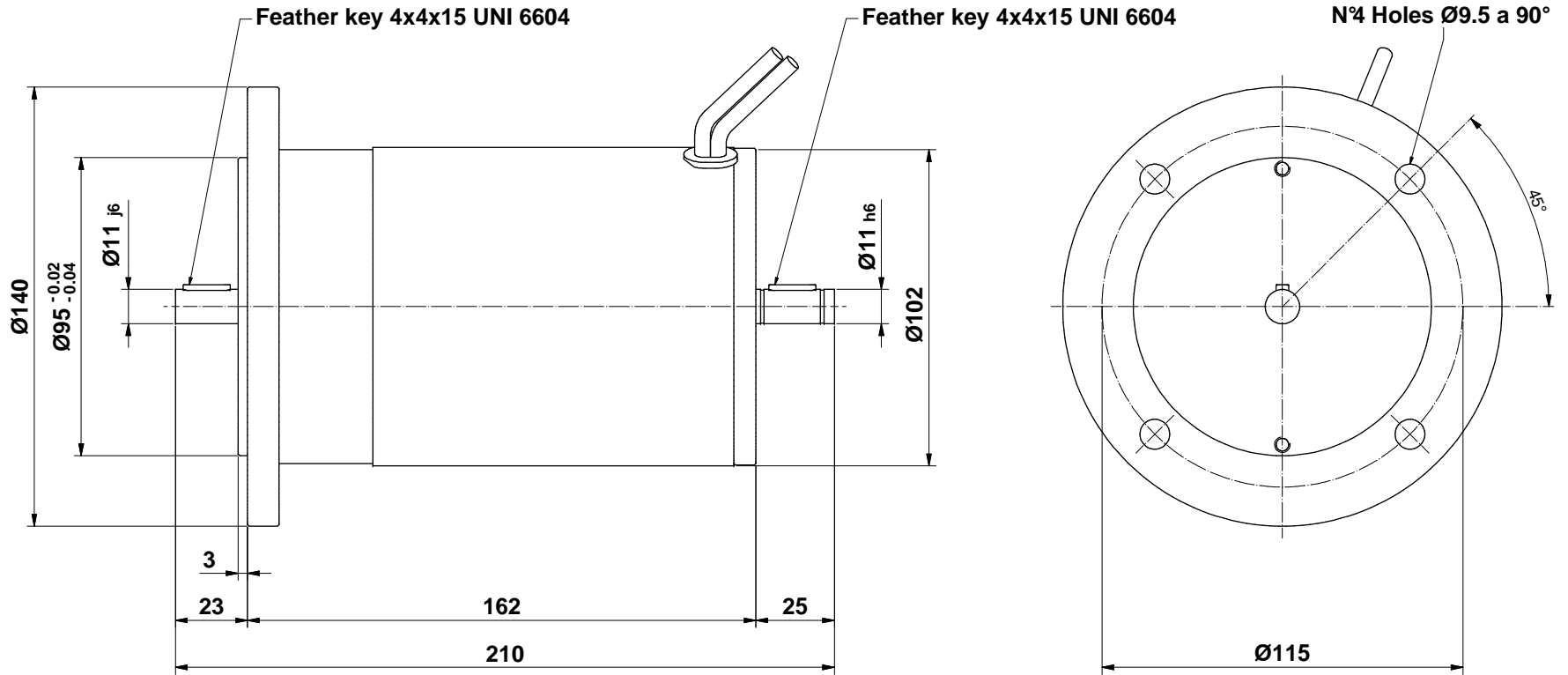

PERMANENT MAGNET MOTOR

Scala : 1 : 1.5
Scale :

