



C.F.R. S.r.l.
Modena - Italy

POTENZA
POWER
100 W

TENSIONE
TENSION
12 V

VELOCITA'
SPEED
1800 Rpm

COPPIA
TORQUE
0.53 Nm

PROTEZIONE
ENCLOSURE
IP **44**

PESO
WEIGHT
5 Kg

CODICE
CODE
MP102.S0003
DATA
DATE
30/03/2009

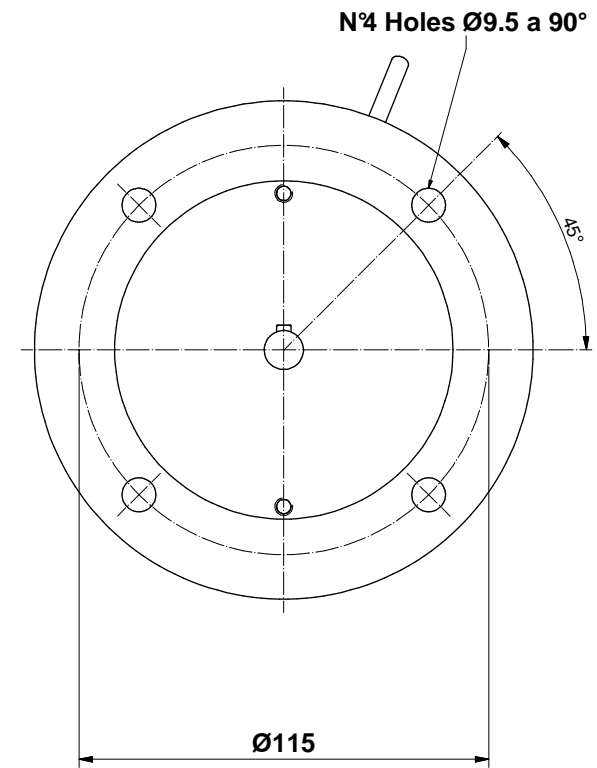
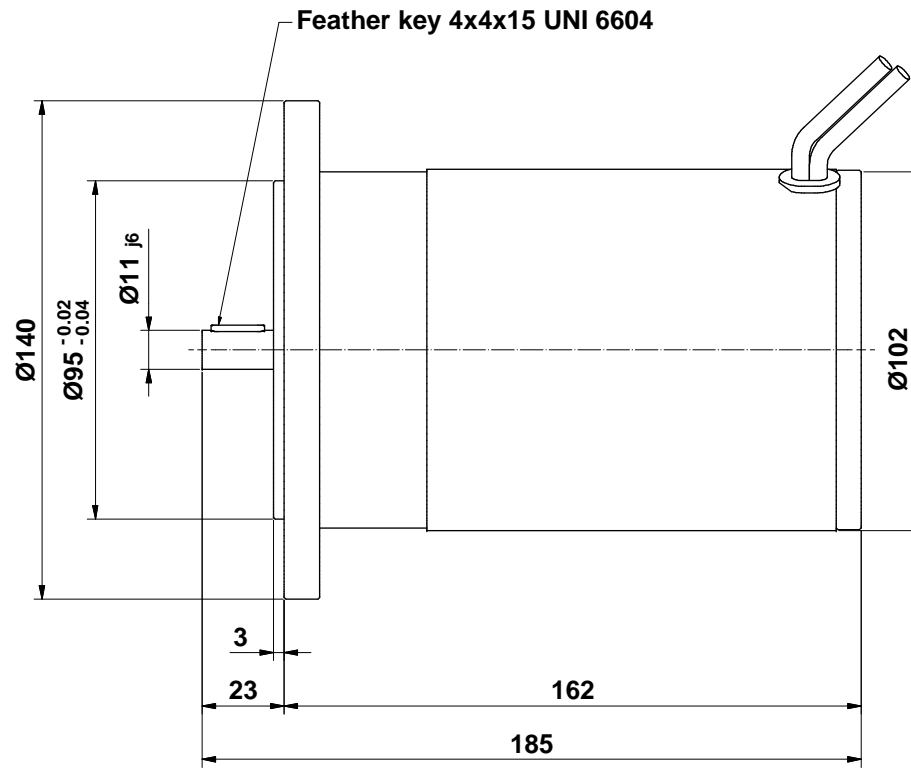

PERMANENT MAGNET MOTOR

Scala : 1 : 1.5
Scale :

